



PX/PPC SERIES

Kanatlı Yemleme Redüktörleri
Gearmotors for Poultry Farms



Kataloğumuzda yer alan bilgileri, önceden haber vermeksizin kısmen veya tamamen deęiřtirme veya iptal etme hakkını saklı tutmaktayız /
We reserve the right to our company to make changes or modifications to catalogue without prior notice.

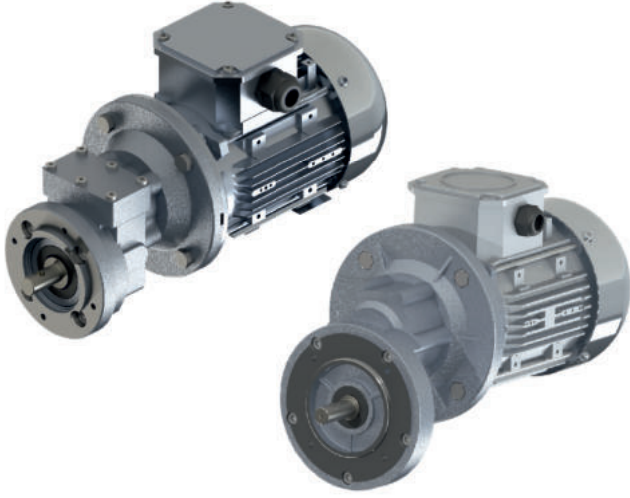

Motorlu Redüktör
Geared Motor

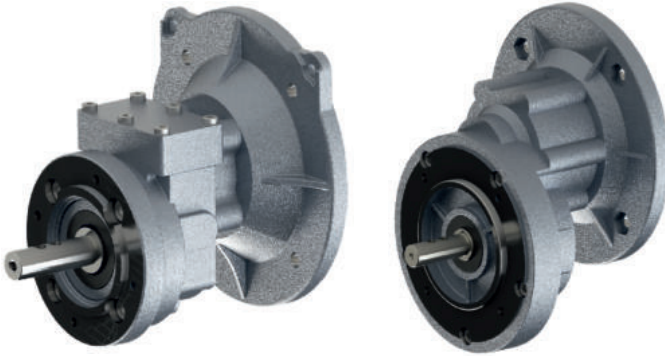

Yuvarlak Çıkış Flanşlı,
B5 / B14 Motor Bağlantı Flanşlı Redüktör

Gear Unit,
with B5 / B14 Motor Connecting and
Round Output Flange

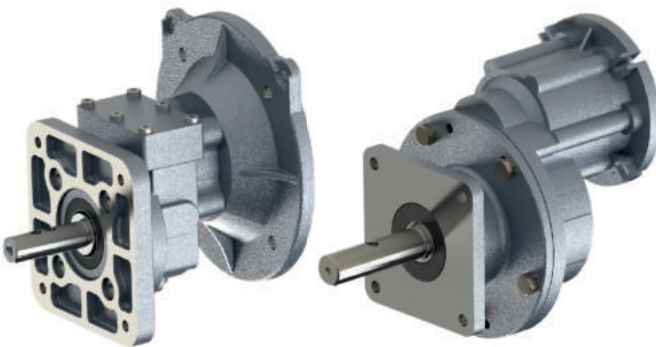

Kare Çıkış Flanşlı
B5 / B14 Motor Bağlantı Flanşlı Redüktör

Gear Unit,
with B5/B14 Motor Connecting and
Squared Output Flange

TR

GİRİŞ

PGR olarak yeniliklere devam ediyoruz. Ürün gamımızı daha da çeşitlendirerek PX 031 / PPC 071-080 redüktörlerimizi ürettik. Yemleme redüktörü olarak adlandırdığımız bu ürünlerimiz, kümes hayvanları çiftliklerinde besleme sistemleri için özel olarak tasarlanmıştır.

Tek kademelidir. Bütün redüktör gövdeleri, basınçlı alüminyum alaşımli dökümdür ve ağır çalışma koşullarına uygun olarak imal edilmiştir. Dişliler, helisel olup sementasyon çeliğinden imal edilmiştir ve sertleştirilmiştir. Çıkış milleri, ıslah çeliğinden imal edilmiştir ve sertleştirilmiştir. Rulmanlar, 20.000 çalışma saatinde hesap edilmiştir.

Müşteri isteğine göre özel değişiklikler yapıp, düşük maliyetli çözümler sunulmaktadır.

PX 031 / PPC 071-080 redüktörlerimiz, hem motorsuz PAM B5/B14 flanşlar ile hem de B5/B14 flanş motorlu olarak müşteriye sunulmaktadır.

Her müşterinin özel taleplerine cevap verebilmek için, çıkış flanşlarında ve çıkış millerinde çok geniş seçim olanağı sunulmaktadır.

PX 031 / PPC 071-080 redüktörlerimiz, sentetik yağlı olarak sevk edilmektedir. İçerisindeki yağ miktarı bütün montaj pozisyonları için uygundur. Sipariş verirken herhangi bir montaj pozisyonu belirtilmesine gerek yoktur.

EN

INTRO

We are going on innovations as a PGR Company. We are designed and produced a new gearbox type that names are PX 031 / PPC 071-080 by more diversification our product range. They have been specifically designed for feeding systems in poultry farms.

It is a single stage. All housings are in die-cast aluminium alloy and for suitable heavy working conditions. The gears are helical and are made of case-hardened and tempered alloy steel. The output shafts are in hardened-tempered alloy steel. The bearings are calculated for an average life for 20.000 working hours.

A low cost solution with a high degree of customization.

PX 031 / PPC 071-080 gearboxes can be supplied complete with B5/B14 flange motor or fitted for motor connecting (PAM).

A wide selection of input/output flanges and output shafts is available in order to satisfy each customers specific demand.

PX 031 / PPC 071-080 gearboxes are delivered complete with synthetic oil in enough quantity for the installation of the gearbox in all mounting positions, without specifying them at order time.

TASARIM / DESIGNATION

PX 031 - PAM 80 B5 - 4,21 - Ø140 - Ø19

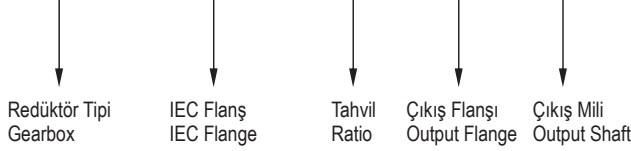

PPC 071 - 71M/4A B5 - 3,00 - FA - Ø20

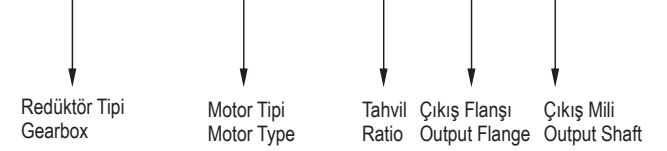

PX 031 PERFORMANS TABLOSU / PX 031 PERFORMANCE TABLE

i	n1 (1/min)	n2 (1/min)	M2 max (Nm)	P max (kW)	PAM
2,55	1400	549	19	1,10	71B5 80B5
2,94	1400	476	20	1,00	71B5 80B5
3,18	1400	440	20	0,94	71B5
3,36	1400	417	20	0,90	80B5
3,87	1400	362	21	0,80	71B5
4,21	1400	333	21	0,75	80B5
4,75	1400	295	23	0,72	71B5 80B5
5,10	1400	275	23	0,66	71B5
6,30	1400	222	23	0,55	71B5
7,87	1400	178	24	0,45	71B5

PPC 071-080 PERFORMANS TABLOSU / PPC 071-080 PERFORMANCE TABLE

Tip / Type	i	n1 (1/min)	n2 (1/min)	M2 max (Nm)	P max (kW)	PAM
PPC 071	3,00	1400	467	12	0,55	71B5 / B14
PPC 080	3,00	1400	467	22	1,10	80B5 / B14

TR

MONTAJ POZİSYONLARI

EN

INTRO

PX
031

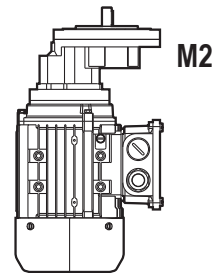
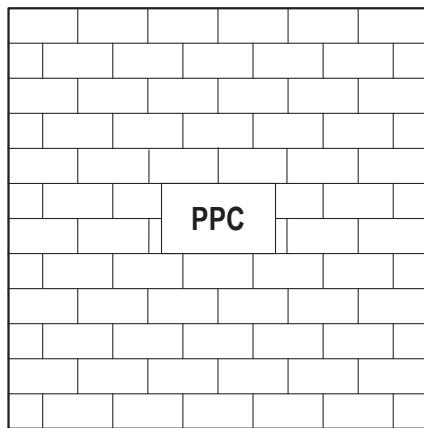
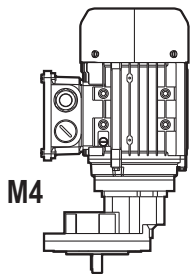
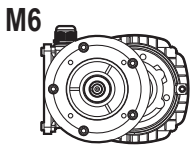
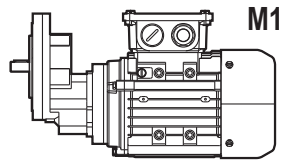
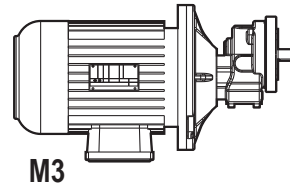
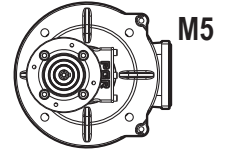
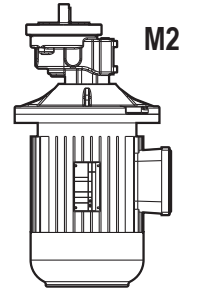
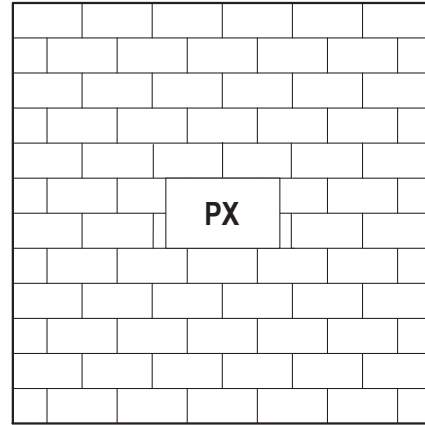
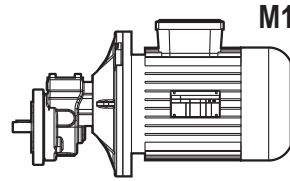
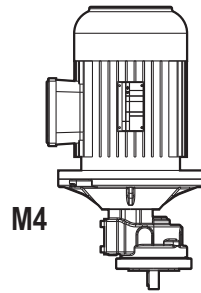
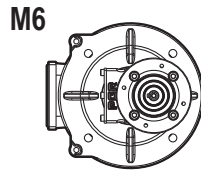

PPC

071
080

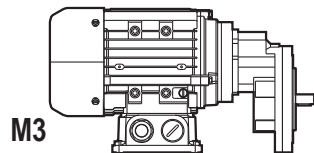
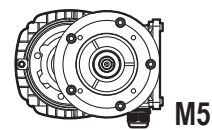

TR

TERMİNAL KUTUSUNUN POZİSYONU

EN

POSITION OF TERMINAL BOX

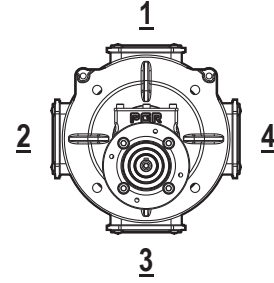
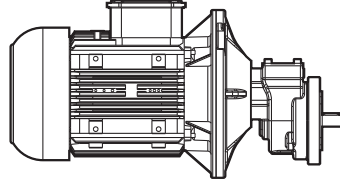
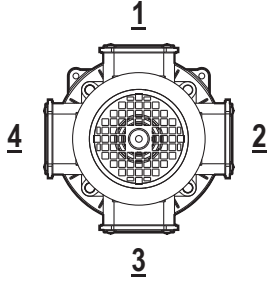

PX/PPC

M1	M6	M4	M2
M3	M5		

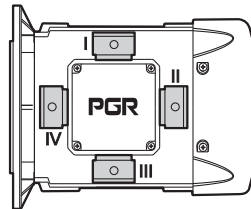

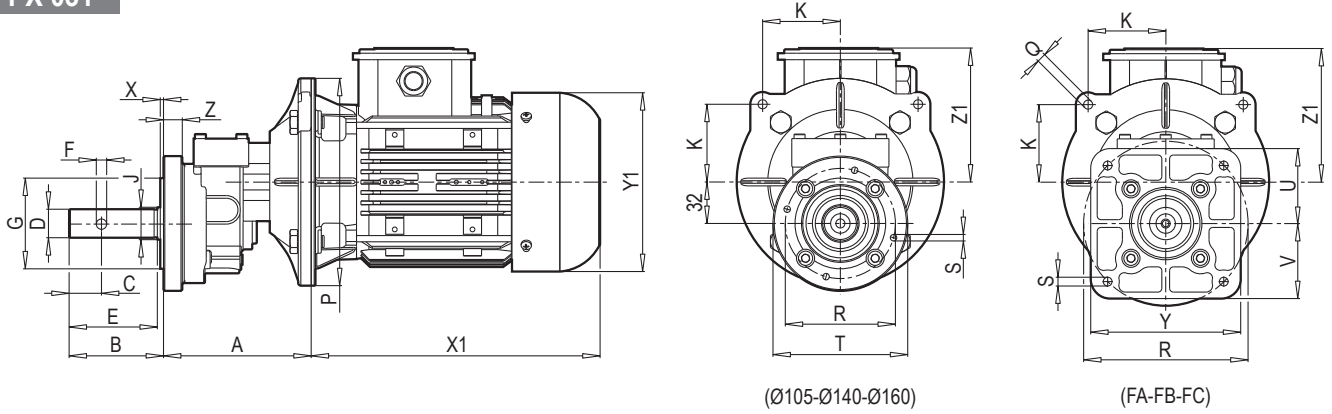
PX 031

B5 FLANŞLI, MOTORLU / WITH MOTOR in B5

MOTOR	A	K	P	Q	X1	Y1	Z1
71B5	110 *x	60	Ø 160	Ø 7	223	140	119
80B5	120 *y	75	Ø 200	Ø 7	244	159	127

*x: Çıkış flanşı Ø105 için A=112 / With the output flange Ø 105 the dimension A=112

*y: Çıkış flanşı Ø105 için A=122 / With the output flange Ø 105 the dimension A=122

ÇIKIŞ FLANŞI / OUTPUT FLANGE

Tip / Type	G	Y	R	S	T	U	V	X	Z
105	Ø 70	-	Ø 85	M6*w	Ø 105	-	-	2,5	14,5
140	Ø 95	-	Ø 115	9,5	Ø 140	-	-	3	9
160	Ø 110	-	Ø 130	9,5	Ø 160	-	-	3	11
FA	-	116	Ø 127	M8	-	58	58	-	-
FB	-	138	Ø 127	M8	-	69	60	-	-
FC	-	150	Ø 165	Ø11	-	75	75	-	-

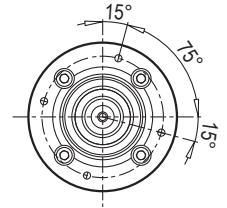

*w: Özel vida açılmış delik / Special tapped holes

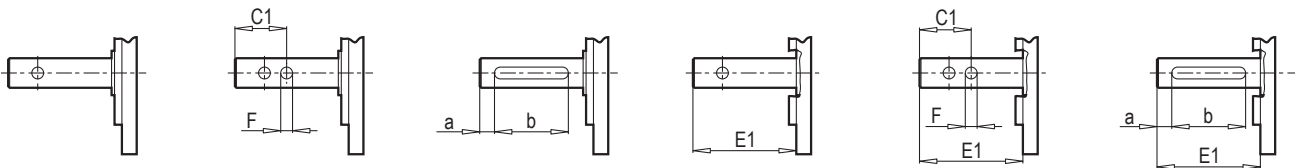
ÇIKIŞ MİLİ SEÇENEKLERİ / OUTPUT SHAFT OPTIONS
1 / 1-A
2
3
4
5
6

Tip / Type	Mil / Shaft	B	C	C1	D	E	E1	F	J	a	b
6	Ø14*z	-	-	-	Ø 14	-	30	-	25	5	20
4	Ø16	-	21	-	Ø 16	-	50	Ø 7	25	-	-
1	Ø19	65	23	-	Ø 19	60	-	Ø 6.5	25	-	-
1-A	Ø19	85	30	-	Ø 19	80	-	Ø 8.5	25	-	-
2	Ø19	65	23	38	Ø 19	60	-	Ø 6.5	25	-	-
4	Ø19	-	50	-	Ø 19.7	-	100	Ø 6	25	-	-
5	Ø19	-	30	50	Ø 19.7	-	100	Ø 6	25	-	-
6	Ø19	-	-	-	Ø 19	-	40	-	25	5	30
1	Ø20	57	23	-	Ø 20	52	-	Ø 6.5	25	-	-
1-A	Ø20	85	30	-	Ø 20	75	-	Ø 6	25	-	-
6	Ø20	-	-	-	Ø 20	-	40	-	25	5	30
1	Ø22	57	23	-	Ø 22	52	-	Ø 8.5	25	-	-
1-A	Ø22	65	24	-	Ø 22	60	-	Ø 8.5	25	-	-
2	Ø24	125	15	30	Ø 24	120	-	Ø 9	25	-	-

*z: Sadece çıkış flanşı Ø105 için kullanılabilir / Shaft valid only with the output flange Ø105

PX 031

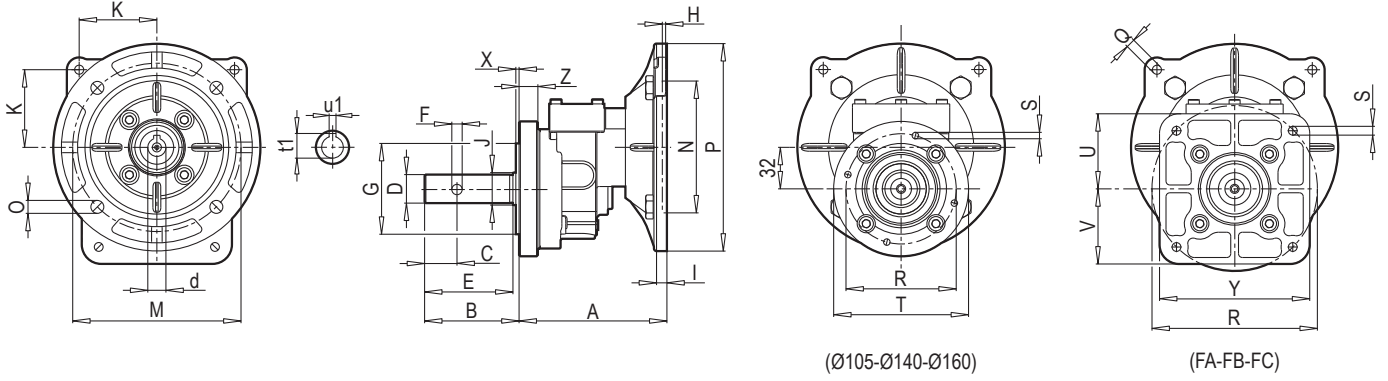

B5 MOTOR BAĞLANTI FLANŞI / INPUT FLANGE in B5

PAM	A	d	H	I	K	M	N	O	P	Q	t1	u1
71B5	110 *x	Ø 14	4	10	60	Ø 130	Ø 110	Ø 9	Ø 160	Ø 7	16,3	5
80B5	120 *y	Ø 19	4	11	75	Ø 165	Ø 130	Ø 11	Ø 200	Ø 7	21,8	6

*x: Çıkış flanşı Ø105 için A=112 / With the output flange Ø 105 the dimension A=112

*y: Çıkış flanşı Ø105 için A=122 / With the output flange Ø 105 the dimension A=122

ÇIKIŞ FLANŞI / OUTPUT FLANGE

Tip / Type	G	Y	R	S	T	U	V	X	Z
105	Ø 70	-	Ø 85	M6*w	Ø 105	-	-	2,5	14,5
140	Ø 95	-	Ø 115	9,5	Ø 140	-	-	3	9
160	Ø 110	-	Ø 130	9,5	Ø 160	-	-	3	11
FA	-	116	Ø 127	M8	-	58	58	-	-
FB	-	138	Ø 127	M8	-	69	60	-	-
FC	-	150	Ø 165	Ø11	-	75	75	-	-

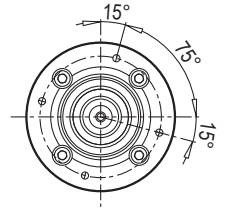

*w: Özel vida açılmış delik / Special tapped holes

ÇIKIŞ MİLİ SEÇENEKLERİ / OUTPUT SHAFT OPTIONS

1 / 1-A

2

3

4

5

6

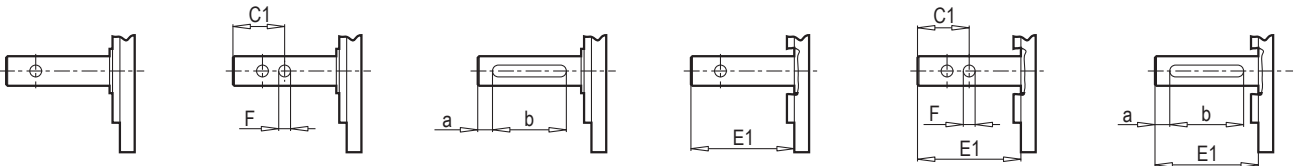

Tip / Type	Mil / Shaft	B	C	C1	D	E	E1	F	J	a	b
6	Ø14*z	-	-	-	Ø 14	-	30	-	25	5	20
4	Ø16	-	21	-	Ø 16	-	50	Ø 7	25	-	-
1	Ø19	65	23	-	Ø 19	60	-	Ø 6.5	25	-	-
1-A	Ø19	85	30	-	Ø 19	80	-	Ø 8.5	25	-	-
2	Ø19	65	23	38	Ø 19	60	-	Ø 6.5	25	-	-
4	Ø19	-	50	-	Ø 19.7	-	100	Ø 6	25	-	-
5	Ø19	-	30	50	Ø 19.7	-	100	Ø 6	25	-	-
6	Ø19	-	-	-	Ø 19	-	40	-	25	5	30
1	Ø20	57	23	-	Ø 20	52	-	Ø 6.5	25	-	-
1-A	Ø20	85	30	-	Ø 20	75	-	Ø 6	25	-	-
6	Ø20	-	-	-	Ø 20	-	40	-	25	5	30
1	Ø22	57	23	-	Ø 22	52	-	Ø 8.5	25	-	-
1-A	Ø22	65	24	-	Ø 22	60	-	Ø 8.5	25	-	-
2	Ø24	125	15	30	Ø 24	120	-	Ø 9	25	-	-

*z: Sadece çıkış flanşı Ø105 için kullanılabilir / Shaft valid only with the output flange Ø105

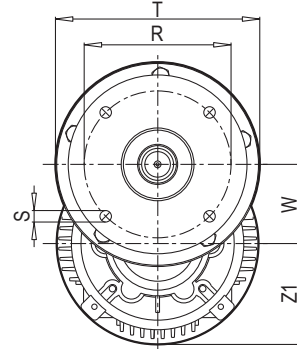
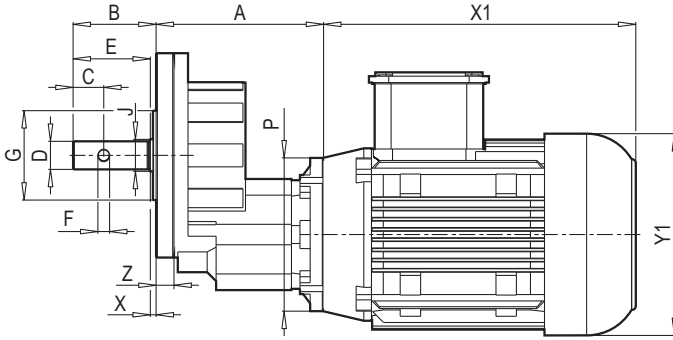
PPC 071 - 080

(Ø105-Ø140-Ø160)

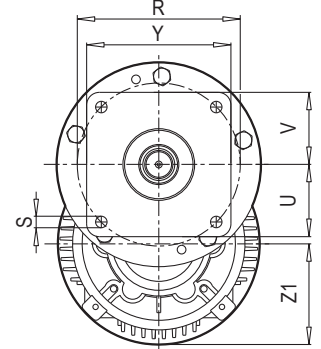

(FA-FB-FC)

B5/B14 FLANŞLI, MOTORLU / WITH MOTOR in B5/B14

TİP/TYPE	MOTOR	A	P	W	X1	Y1	Z1
PPC 071	71B5 / B14	138	Ø160 / Ø105	52	223	140	119
PPC 080	80B5 / B14	170	Ø200 / Ø120	62	244	159	127

ÇIKIŞ FLANŞI / OUTPUT FLANGE

Tip / Type	G	Y	R	S	T	U	V	X	Z
105	Ø 70	-	Ø 85	M6*w	Ø 105	-	-	2,5	14,5
140	Ø 95	-	Ø 115	9,5	Ø 140	-	-	3	9
160	Ø 110	-	Ø 130	9.5	Ø 160	-	-	3	11
FA	-	116	Ø 127	M8	-	58	58	-	-
FB	-	138	Ø 127	M8	-	69	60	-	-
FC	-	150	Ø 165	Ø11	-	75	75	-	-

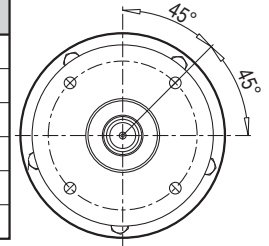

*w: Özel vida açılmış delik / Special tapped holes

ÇIKIŞ MİLİ SEÇENEKLERİ / OUTPUT SHAFT OPTIONS

1 / 1-A

2

3

4

5

6

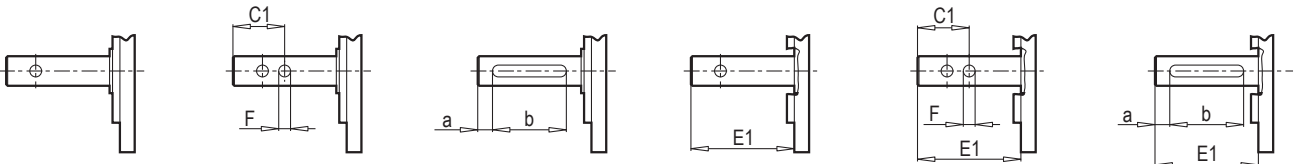

Tip / Type	Mil / Shaft	B	C	C1	D	E	E1	F	J	a	b
6	Ø14*z	-	-	-	Ø 14	-	30	-	25	5	20
4	Ø16	-	21	-	Ø 16	-	50	Ø 7	25	-	-
1	Ø19	65	23	-	Ø 19	60	-	Ø 6.5	25	-	-
1-A	Ø19	85	30	-	Ø 19	80	-	Ø 8.5	25	-	-
2	Ø19	65	23	38	Ø 19	60	-	Ø 6.5	25	-	-
4	Ø19	-	50	-	Ø 19.7	-	100	Ø 6	25	-	-
5	Ø19	-	30	50	Ø 19.7	-	100	Ø 6	25	-	-
6	Ø19	-	-	-	Ø 19	-	40	-	25	5	30
1	Ø20	57	23	-	Ø 20	52	-	Ø 6.5	25	-	-
1-A	Ø20	85	30	-	Ø 20	75	-	Ø 6	25	-	-
6	Ø20	-	-	-	Ø 20	-	40	-	25	5	30
1	Ø22	57	23	-	Ø 22	52	-	Ø 8.5	25	-	-
1-A	Ø22	65	24	-	Ø 22	60	-	Ø 8.5	25	-	-
2	Ø24	125	15	30	Ø 24	120	-	Ø 9	25	-	-

*z: Sadece çıkış flanşı Ø105 için kullanılabilir / Shaft valid only with the output flange Ø105

PPC 071 - 080

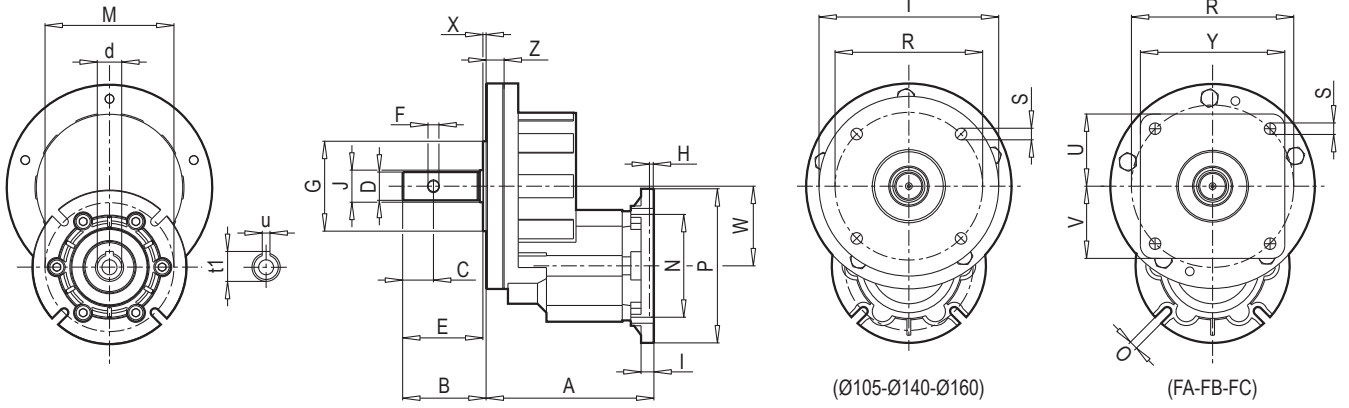

B5/B14 MOTOR BAĞLANTI FLANŞI / INPUT FLANGE in B5/B14

TİP/TYPE	PAM	A	Ød	H	I	M	N	O	P	t1	u1	W
PPC 071	71B5 / B14	138	Ø 14	4	10	Ø130 / Ø85	Ø110 / Ø70	Ø 9	Ø160 / Ø105	16,3	5	52
PPC 080	80B5 / B14	170	Ø 19	4	11	Ø165 / Ø100	Ø130 / Ø80	Ø 11	Ø200 / Ø120	21,8	6	62

ÇIKIŞ FLANŞI / OUTPUT FLANGE

Tip / Type	G	Y	R	S	T	U	V	X	Z
105	Ø 70	-	Ø 85	M6*w	Ø 105	-	-	2,5	14,5
140	Ø 95	-	Ø 115	9,5	Ø 140	-	-	3	9
160	Ø 110	-	Ø 130	9,5	Ø 160	-	-	3	11
FA	-	116	Ø 127	M8	-	58	58	-	-
FB	-	138	Ø 127	M8	-	69	60	-	-
FC	-	150	Ø 165	Ø11	-	75	75	-	-

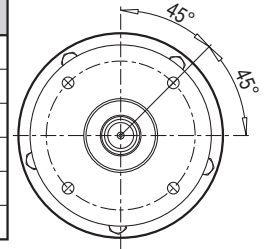

*w: Özel vida açılmış delik / Special tapped holes

ÇIKIŞ MİLİ SEÇENEKLERİ / OUTPUT SHAFT OPTIONS

1 / 1-A

2

3

4

5

6

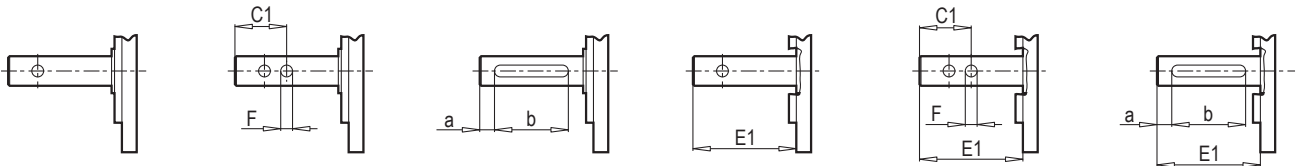

Tip / Type	Mil / Shaft	B	C	C1	D	E	E1	F	J	a	b
6	Ø14*z	-	-	-	Ø 14	-	30	-	25	5	20
4	Ø16	-	21	-	Ø 16	-	50	Ø 7	25	-	-
1	Ø19	65	23	-	Ø 19	60	-	Ø 6.5	25	-	-
1-A	Ø19	85	30	-	Ø 19	80	-	Ø 8.5	25	-	-
2	Ø19	65	23	38	Ø 19	60	-	Ø 6.5	25	-	-
4	Ø19	-	50	-	Ø 19.7	-	100	Ø 6	25	-	-
5	Ø19	-	30	50	Ø 19.7	-	100	Ø 6	25	-	-
6	Ø19	-	-	-	Ø 19	-	40	-	25	5	30
1	Ø20	57	23	-	Ø 20	52	-	Ø 6.5	25	-	-
1-A	Ø20	85	30	-	Ø 20	75	-	Ø 6	25	-	-
6	Ø20	-	-	-	Ø 20	-	40	-	25	5	30
1	Ø22	57	23	-	Ø 22	52	-	Ø 8.5	25	-	-
1-A	Ø22	65	24	-	Ø 22	60	-	Ø 8.5	25	-	-
2	Ø24	125	15	30	Ø 24	120	-	Ø 9	25	-	-

*z: Sadece çıkış flanşı Ø105 için kullanılabilir / Shaft valid only with the output flange Ø105



POLAT GROUP REDÜKTÖR SAN. ve TİC. A.Ş.

- ATA OSB Mah. Astim 1.Cad. No: 4 Efeler - Aydın / TÜRKİYE
- T: +90 256 231 19 12 • F: +90 256 231 19 17 • info@pgr.com.tr • www.pgr.com.tr

Dok. No: PG.KT.GT.013

Rev. / Yayın Tarihi: 12.2025_R1